

Product Parts Breakdown

▲ Specify Finish

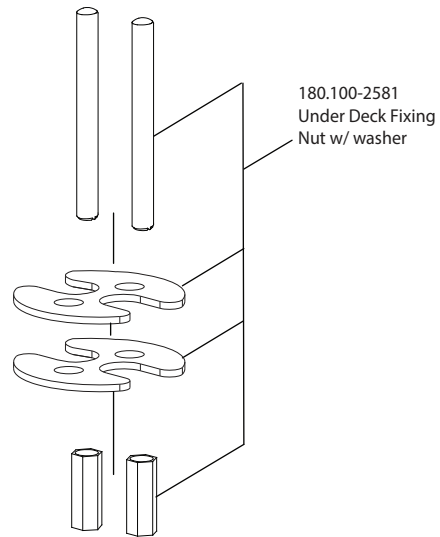
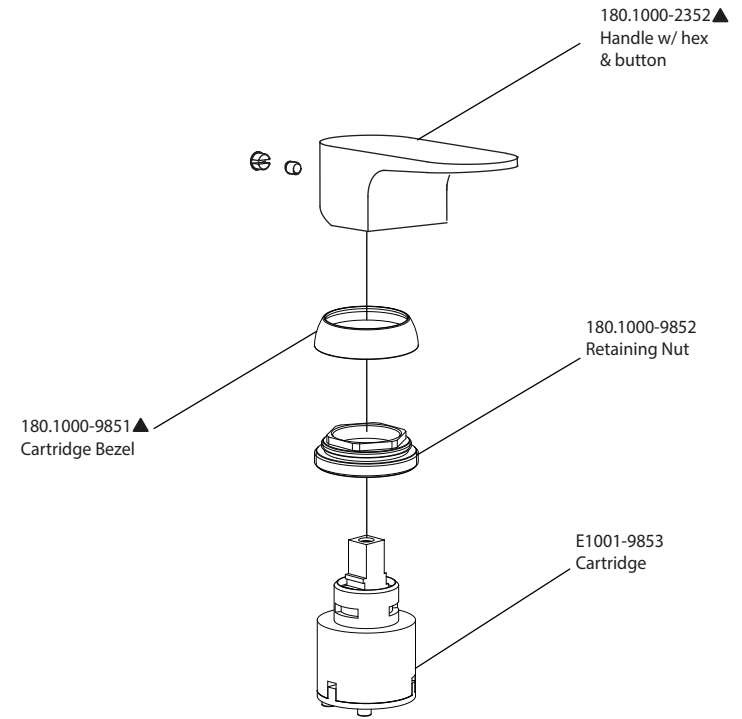
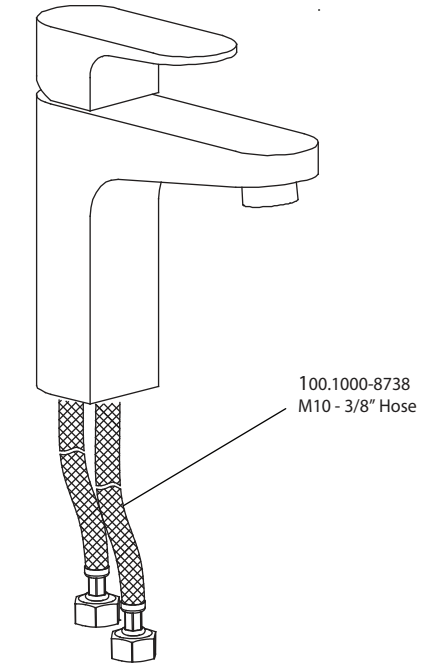

isenberg
innovation+design

180.1000

Ver 2.53